



NovoSpeed Solutions

Fast logistic solutions



Novoform subsidiaries and sites

- Novoform production site
- Novoform sales office

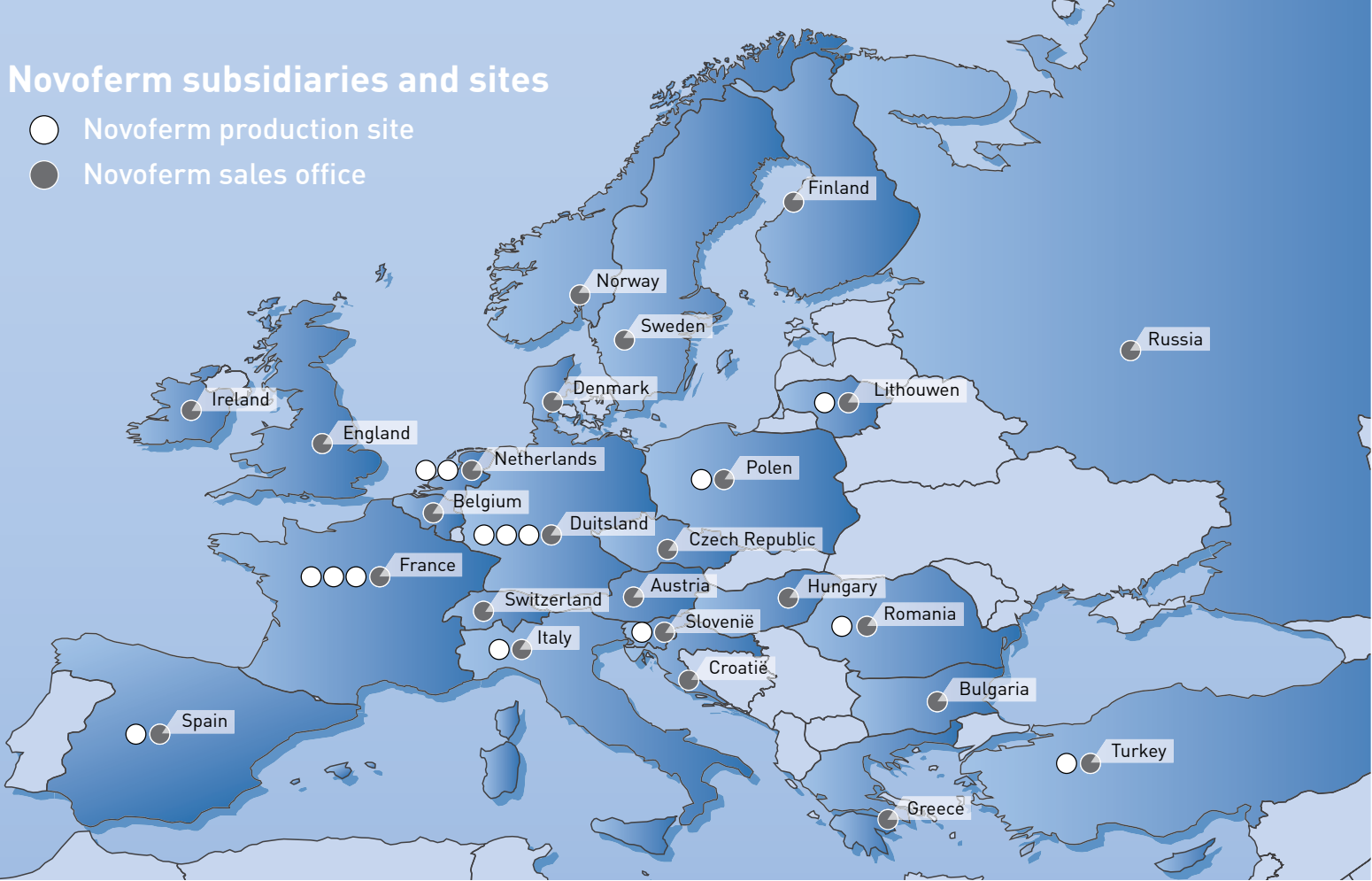

Novoform: your access partner for industrial buildings

Novoform has specialised in many forms of access and exit door systems for industrial buildings and homes for more than thirty years. An extensive choice of designs, finishes, controls and installation options means that you always benefit from a customised solution. We take responsibility for the whole process from initial specification advice to development, production, assembly and even assistance with construction coordination if required. Obviously, we also monitor aspects such as the associated standards and legislation very closely; — something that saves you significant work and extra effort.

In addition to industrial doors, draught-excluding and fire rated doors Novoform also offers products for the goods delivery and despatch areas in industrial and commercial buildings. Novoform is part of the Sanwa Shutter Corporation, a leading producer of doors, garage doors and other products for equipping buildings worldwide, so choosing a Novoform product not only guarantees you the most modern and up-to-date technology available, you also benefit from maximum quality, reliability, comfort and design at minimum cost!

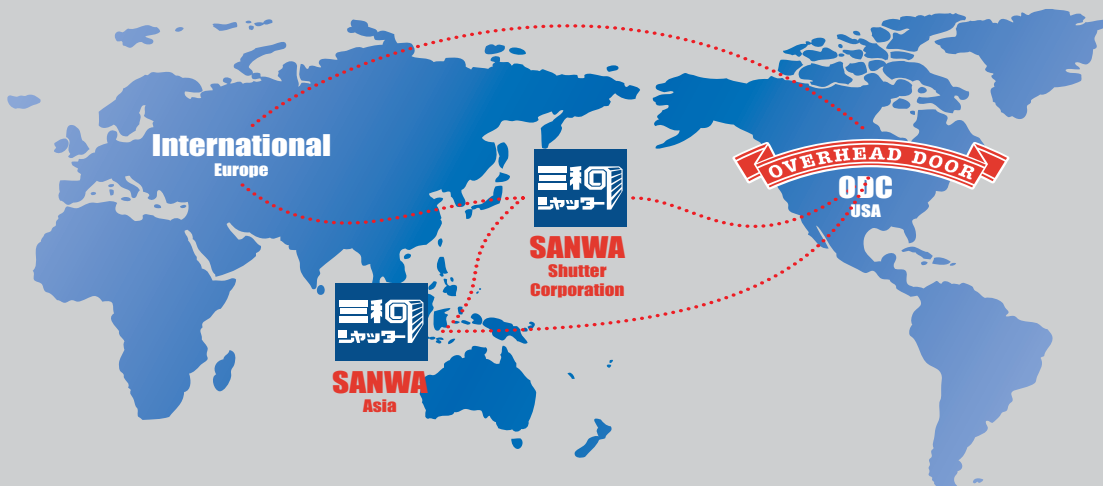



Contents

- Why choose a Novoferm rapid roll door? 4
- Applications 6
- Product overview 8

Interior applications

- NovoSpeed **RETAIL** 11
- NovoSpeed **FLEX 2.0 HardEdge** 12
- NovoSpeed **FLEX 2.0 FlexEdge** 13
- SpeedRoller **PRIME** 14
- SpeedRoller **STRONG** 15
- NovoSpeed **HEAVY Indoor** 16
- NovoSpeed **HEAVY** 17
- NovoSpeed **POLARA** 18
- NovoSpeed **EASY CLIP** 19
- NovoSpeed **SWING DOORS** 19

Exterior applications

- NovoSpeed **THERMO** 21
- NovoSpeed **ALU R** 22
- NovoSpeed **HEAVY Outdoor** 23

Other solutions

- NovoSpeed controls 24
- Accessories 26
- Additional controls 27

Technical specifications

- Overview of NovoSpeed doors / flexible doorcurtain 28
- Overview of NovoSpeed doors / rigid door panels 30

References

- Selected reference projects 31

Safe doors

All automatic doors must comply with European Directive EN 13241. Novoferm develops and produces its new products strictly in line with these standards. As a result, you are guaranteed safe operation during daily use, assembly and maintenance.



www.novoferm.co.uk

Why choose a Novoferm rapid roll door?

Different situations demand different solutions



Working efficiently means working economically. Novoferm rapid roll doors help you improve your logistic performance. Novoferm offers a customized solution for almost every situation. Our in-house research and development departments respond alertly to changes in the requirements that rapid roll doors have to satisfy.

Industrial buildings already have to comply with increasingly stringent energy saving requirements and this trend is forecast to continue. Research performed by the Technical University of Munich has shown that rapid roll doors have a significant effect on the amount of energy consumed in industrial buildings. The study shows that the interior temperature of a building or room plummets when the door is left open (depending on the temperature differential and type of building). Consequently, the shorter the period of time that a door remains open, the lower the drop in interior temperature. Draughts are also significantly reduced, which helps maintain a more comfortable environment in the building and reduces sickness absenteeism.

Working efficiently means working economically

When a door is used infrequently, insulation is of great importance. However, when a door is used frequently, the speed at which it opens and closes, and the height to which it opens, are much more significant. The latest generation of Novoferm control units features an adjustable half-height stop setting as standard. In combination with the "Auto-close" function, this feature allows you to achieve considerable energy savings.

Regardless of the type of door, the energy loss through an open door will always far exceed the degree of energy loss due to heat transfer and air leakage through a closed door. Research at the Technical University of Munich has shown that installing fast-action (roller) doors and avoiding long periods spent in the open position can reduce the additional energy requirements by as much as **30%**! Interlocking two doors to create an air lock results in even greater savings and can improve the interior climate by up to **90%**.

Efficient use of energy, also during production

Novoferm signed the group's 'Green Solutions' Charter In 2009. This consists of a package of concrete measures designed to reduce CO²-emissions during production, delivery, assembly and maintenance of industrial doors.

100 % recyclable materials



This is a goal that we consistently pursue. As a result, we select our raw materials and resources with great care, adding our own sustainable in-house development procedures into the equation. For instance, our control units are completely lead-free and comply with RoHS requirements. So we have already assumed a leading role in this area.

Single-source manufacturer and supplier

Novoferm not only supplies draught excluding products, we also offer a full range of industrial doors, multifunctional passdoors, fire doors and dock equipment. There is a highquality Novoferm product for every opening in a modern industrial building. Doing business with a single partner has the following advantages:

- Single point of contact for all products, installation, maintenance and after sales
- Products are designed for optimum compatibility with each other
- Products are automatically delivered in the correct sequence
- Installers / fitters who are familiar with all of the productst

Energy loss

The illustrations below show how air flow through a conventional outside door (A) results in energy loss. When a high tech rapid roll door from Novoferm (B) is used, the door has already closed again before the air flow reaches the opening.

This maintains the interior temperature at a constant value, saves energy, guarantees pleasant working conditions and reduces sickness absenteeism as an added bonus.

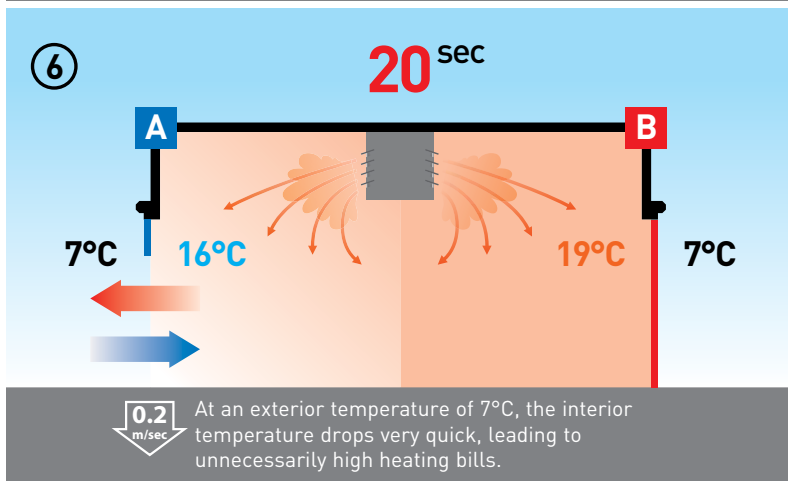
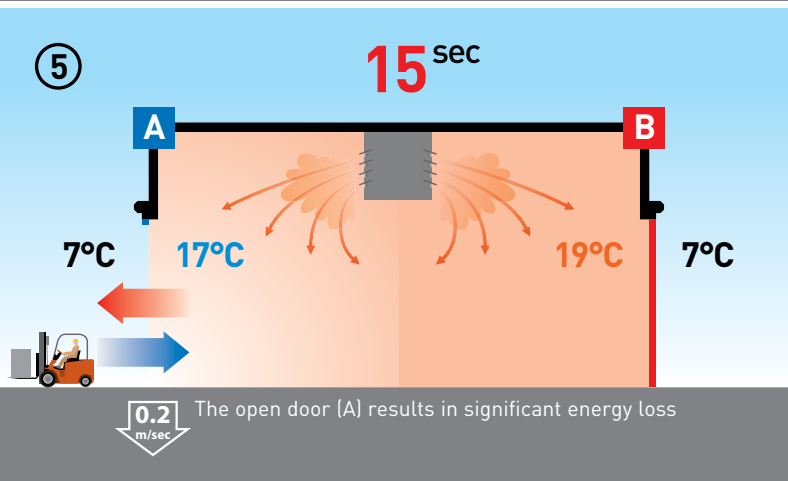
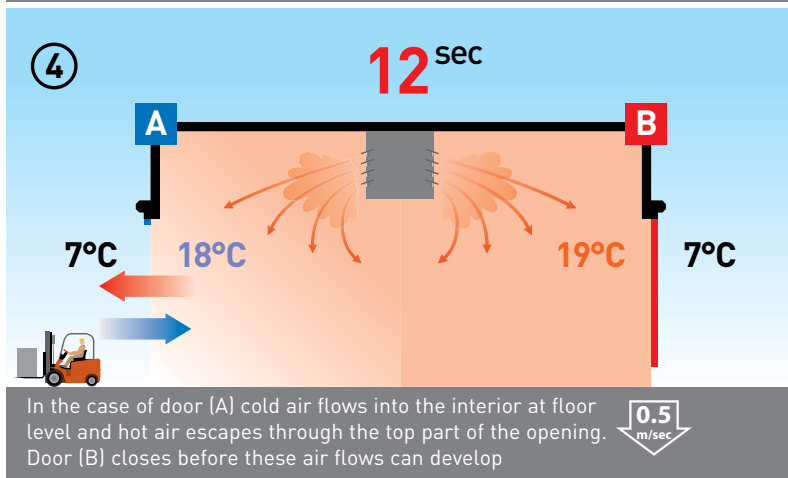
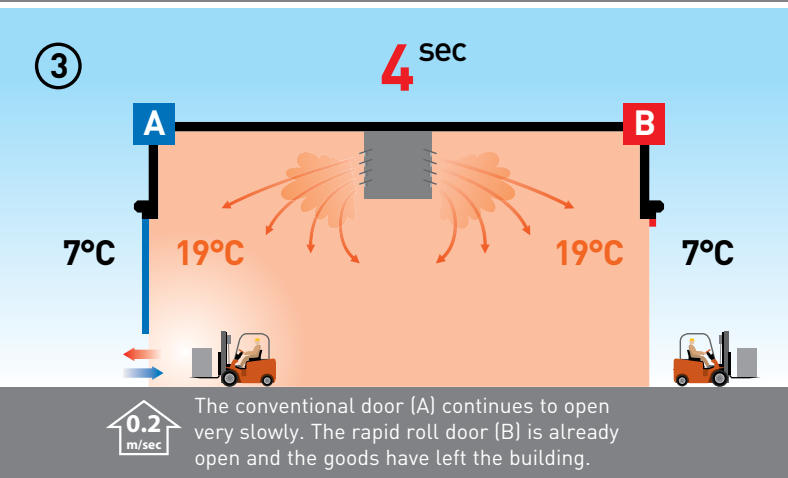
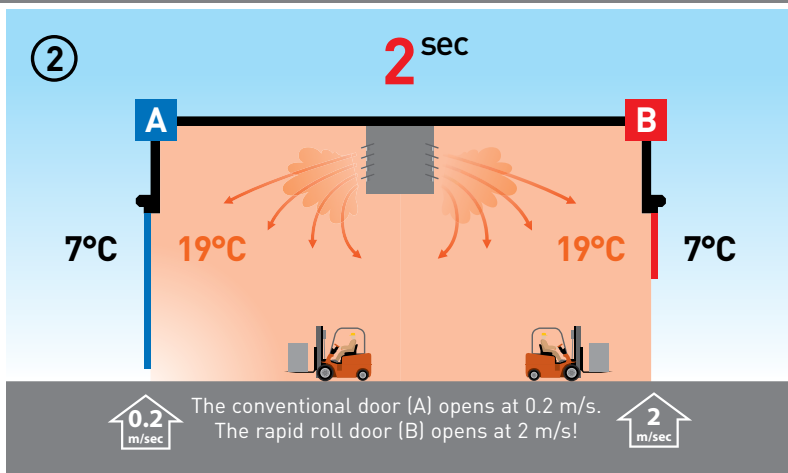
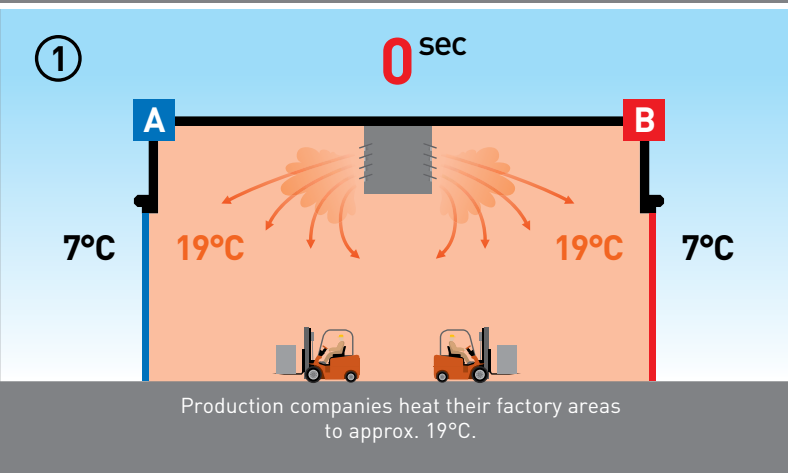

Customer service

When you deal with Novoferm, projects do not simply stop after product installation. Service and maintenance are vital for ensuring continuous product availability, quality and durability. Novoferm offers effective 24-hour service, back-up and a selection of maintenance packages to guarantee your business continuity.

Applications

The extensive range of draught-excluding solutions from Novoferm is used in just about all market sectors. The exact type of door depends on the specific application and the conditions in which it is to operate. Our standard range offers solutions for most situations. Based on your input, we can also engineer and supply custom-made solutions to satisfy any special requirements you may have.



Light and heavy industry

The light and heavy industry sectors require a wide variety of draught-excluding solutions.

Novoferm's extensive range of doors includes suitable solutions for practically any situation in these sectors. These products are easy to assemble, operate reliably for extended periods and require little maintenance. So our products guarantee you operating reliability, business continuity and safety.



Food

Novoferm is a recognised name in the food industry. In Europe we have a long history of supplying our products to major food producers and processors.

We also have extensive experience with cold store manufacturers. We know from experience that this sector involves more than simply using materials such as stainless steel and compliance with strict hygiene requirements, there is also strong demand for custom-made solutions. These usually focus on cost efficiency and ensuring production process continuity.



Retail

In modern supermarkets, the shelves are always well stocked with an extensive range of products. Intensive traffic between the storeroom and the retail shop space is required to keep the shelves filled.

In view of this level of traffic, a rapid roll door is often chosen to separate the retail space from the storeroom. It operates at high speed, opens and closes automatically, is safe for users, hardly takes up any space and is a low-noise product. Novoferm designs and manufactures custom-made doors for various retailers, and currently supplies its products to most leading chain stores in Europe.

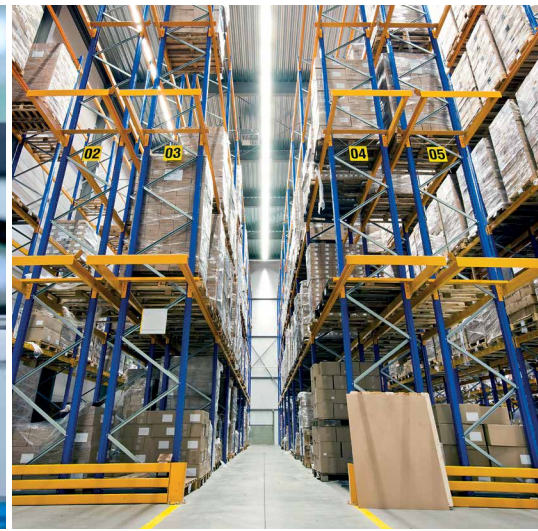

Automotive

A typical car factory produces approximately one thousand cars a day on average. This level of production requires an immense flow of goods and timely delivery is of vital importance.

As a result, the doors used in this logistics flow also have to satisfy demanding requirements. Novoferm offers products that operate dependably under these conditions, day-in and day-out. Novoferm also supports its products with 24/7 service to minimise downtime in the unlikely event of a breakdown.



Pharmaceutical and chemical industry

The pharmaceutical and chemical industries require suppliers to meet challenging standards in the areas of hygiene, sealing, operating reliability, fitting and providing efficient aftersales service.

Not only does Novoferm offer custom-made solutions for these sectors, it also invests significant amounts of time and money in training production staff and technicians. Our technicians and the companies assembling our products for us are SCC certified. So they comply with all of the requirements that apply when working in a strictly regulated operating environment.



Logistics

When products are ready, need to be transported to the end customer as quickly and efficiently as possible. Consequently, many European companies subcontract warehousing, transshipment and delivery to large logistics distribution centres.

The doors involved in these logistic flows often open and close many times a day. Using a top-class product alone is not enough however! Even the best product fails occasionally when used intensively. As preventive maintenance minimises failures of this type, Novoferm offers a range of maintenance and service contracts.

Product overview

Interior doors

11



NovoSpeed Retail

- developed for Retail
- max. 5.85 m²
- class 1 wind resistance
- opening speed: 2 m/s with frequency control
- option for photo print on door curtain

12



NovoSpeed Flex 2.0

- developed for frequently used doorways
- max. 20 m²
- class 0 wind resistance
- opening speed: 2 m/s with frequency control

14



New!

SpeedRoller Prime

- developed for universal use and average wind pressure
- max. 12.25 m²
- class 0 wind resistance or at least 5 Bft
- opening speed: 1 m/s;
- opening speed: 1.5 m/s with frequency control (option)

15



New!

SpeedRoller Strong

- developed for large doorways and average wind pressure
- max. 25 m²
- class 0 wind resistance or at least 5 Bft
- opening speed: 1 m/s
- opening speed: 1.5 m/s with frequency control (option)

16



NovoSpeed Heavy | Indoor

- developed for large, frequently used doorways
- max. 36 m²
- class 0 wind resistance
- opening speed: 1 m/s
- opening speed: 1.5 m/s with frequency control (option)

17



NovoSpeed Heavy

- developed for large, frequently used doorways
- max. 36 m²
- class 0 wind resistance
- opening speed: 1 m/s
- opening speed: 1.5 m/s with frequency control (option)

18



NovoSpeed Polara

- developed for extremely cold conditions
- max. 17.5 m²
- class 0 wind resistance
- opening speed: 1 m/s

19

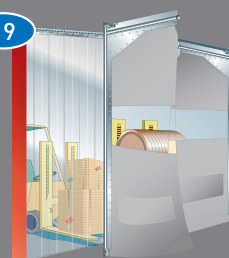

Strip curtains / Swing doors

- developed as an economical alternative

Exterior doors

21



NovoSpeed Thermo

- developed for exterior façades
- max. 25 m²
- class 3 wind resistance
- opening speed: 1.1 m/s with frequency control

22



NovoSpeed Alu | R

- developed for exterior façades
- max. 25 m²
- class 2 wind resistance
- opening speed: 1 m/s with frequency control

23

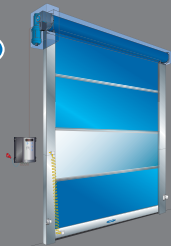

NovoSpeed Heavy | Outdoor

- developed for exterior façades
- max. 36 m²
- class 2 wind resistance
- opening speed: 1 m/s
- opening speed: 1.5 m/s with frequency control (option)

Specially fabricated frames

A specially fabricated frame is generally required to fit a rapid roll door behind an (existing) exterior industrial door. A custom-made frame can be supplied after specification by our technical specialist. This service allows you to single-source your complete door system.



Inside applications – Clever interior door solutions



NovoSpeed RETAIL



These days, supermarkets also have to look attractive. The products on display need to be presented accessibly and appetisingly. The NovoSpeed **Retail** door puts the finishing touches to a successful in-store presentation. This rapid roll interior door with its opening speed of 2 m/s is not just one of the fastest of its kind, it also opens and closes in near silence.

Specifications

NovoSpeed	Retail
max. width (W)	2,250 mm
max. height (H)	2,600 mm
opening speed	2 m/s
closing speed	0.5 m/s
door curtain weight	680 gr/m ²
door curtain thickness	0.7 mm

Product Benefits

- Class 1 windresistance
- compact design of side guides and roller cover
- self-repairing after impact, in one direction
- a safety light curtain is standard
- supplied in the following colours as standard:

5005 9004 9003 7038 7024 3020 2009 1003

The best solution for your store!

The standard tubular motor allows elegant styling without taking up excessive space in the store. And if you truly want to dot your i's and cross your t's in terms of presentation, you can also print your logo or a photographic image on the PVC door curtain.

Safety is obviously the most important consideration in areas with a high customer density such as supermarkets. The NovoSpeed Retail is equipped as standard with a FlexEdge bottom beam and can be supplied with either a mechanical or an automatic emergency opening system for use in the event of a power failure.

Options

- Flex-Edge instead of aluminium lower beam
- counterweight instead of spring for balancing
- industrial integrated drive
- multiple photocells in the side guides
- mechanical release in the event of powerfailure
- door curtain featuring a print of your choice



Standard control unit:

T100R FU

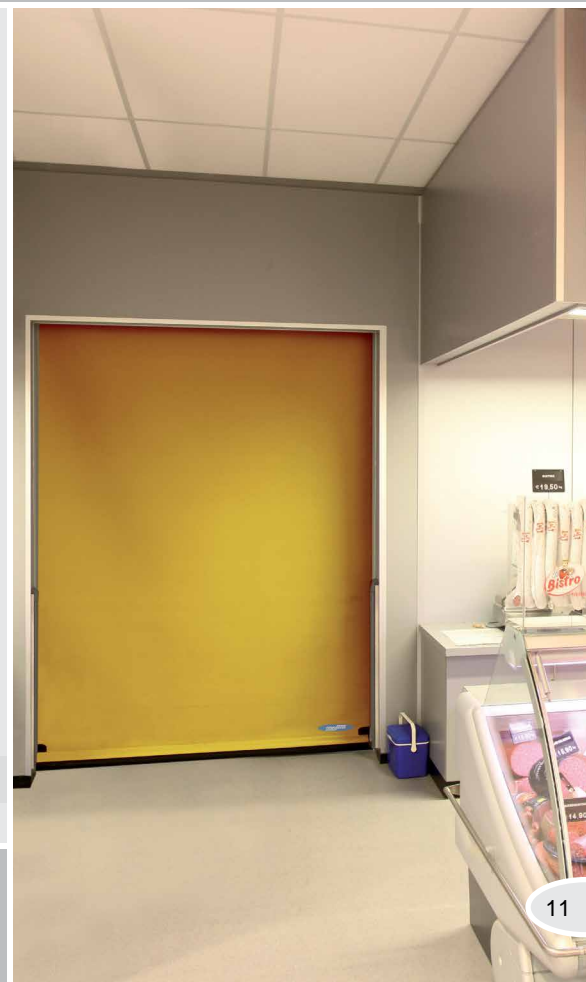

NovoSpeed FLEX 2.0 | HARD EDGE



The NovoSpeed Flex **HardEdge** an electrically operated rapid roll door for the retail sector, general industry and commercial and industrial buildings. The Flex is neatly finished and combines high speed with low noise.

Specifications

NovoSpeed	Flex HardEdge
max. surface area (W x H)	20 m ²
max. width (W)	4,000 mm
max. height (H)	5,000 mm
opening speed	2 m/s
closing speed	0.5 m/s
door curtain weight	1,400 gr/m ²
door curtain thickness	1.2 mm

Product Benefits

- Class 0 windresistance
- self-supporting construction
- 100% self-resetting in both directionstion
- a safety light curtain is standard
- supplied in the following colours as standard:

5005

9004

9003

7038

3020

2009

1023

Attractive, fast and silent

Universal solution

The NovoSpeed Flex is an interior door for universal use in industry. The door is fast and strikingly silent in operation. An industrial drive unit integrated in the roller keeps the side space requirement to a minimum. The advanced control panel is equipped with frequency control as standard, offering many functions and connection possibilities.

Presence detection

An active light curtain is supplied to a maximum height of 2,500 mm. When the door is open, the safety light curtain detects both moving and stationary objects in the opening and prevents the door from closing.

This new generation of NovoSpeed Flex is equipped with two extension springs for door curtain balancing, resulting in a considerably extended service interval.

Options: see page 13 for details of all the options offered for the NovoSpeed Flex

Standard control unit:



T100R FU



Silent integrated drive



Mechanical emergency release

NovoSpeed

FLEX 2.0 | FLEX EDGE



The NovoSpeed Flex **FlexEdge** is an electrically operated rapid roll door for interior applications in the retail sector, general industry and commercial buildings. The flexible bottom beam can not damage your products.

Specifications

NovoSpeed	Flex FlexEdge
max. surface area (W x H)	17.5 m ²
max. width (W)	3,500 mm
max. height (H)	5,000 mm
opening speed	2 m/s
closing speed	0.5 m/s
door curtain weight	1,400 gr/m ²
door curtain thickness	1.2 mm

Product Benefits

- Class 0 windresistance
- self-supporting construction
- 100% self-resetting in both directionstion
- a safety light curtain is standard
- supplied in the following colours as standard:

5005

9004

9003

7038

3020

2009

1023

If your goods are fragile

No damage when collisions occur



100% self-repairing in both directions

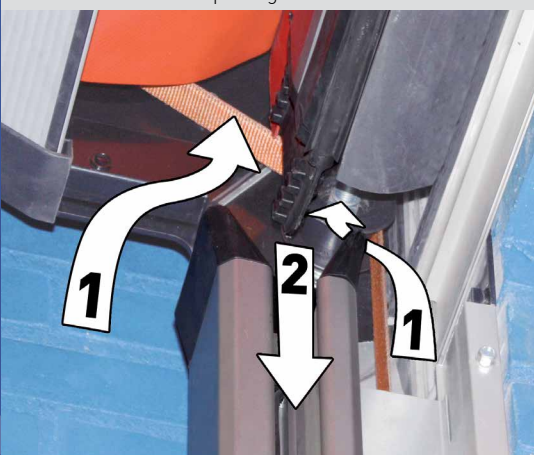

Soft and flexible bottom beam

When closing a rapid roll door in relatively low openings, contact may occur between the bottom beam and the goods being transported. A hard bottom beam might cause damage. The 'FlexEdge' is flexible and soft, thereby increasing safety. Persons or goods that 'accidentally' come into contact with the 'FlexEdge' will suffer little or no damage.

The door opening is monitored in the same way as the 'HardEdge' door.

The following options are available for the NovoSpeed Flex **HardEdge** / **FlexEdge**:

Option 1: mechanical emergency release

Option 2: protective cover in galvanised steel / stainless steel painted in a choice of RAL colours

Option 3: guide columns in costumer-specified RAL colour (powder coating)



Standard control unit:

T100R FU

See the Technical Data on page 28 for more information, or download the Product Data Sheet from www.novoferm.com

SpeedRoller PRIME

NEW!



The SpeedRoller **Prime** is an electrically operated rapid roll door that combines good quality with excellent value for money.

Specifications

SpeedRoller	Prime
max. surface area (W x H)	12.25 m ²
max. width (W)	3,500 mm
max. height (H)	3,500 mm
opening speed	1 m/s
opening speed with frequency control	1.5 m/s
closing speed	1 m/s
closing speed with frequency control	0.5 m/s
door curtain weight	680 gr/m ²
door curtain thickness	0.7 mm

Product Benefits

- Class 0 windresistance or at least 5 Beaufort
- light curtain in the door opening
- suitable for small interior openings and normal wind loads
- supplied in the following colours as standard:

5005 9004 9003 7038 7024 3020 2009 1003

Appearance and performance in perfect harmony

The fast and quiet solution

The SpeedRoller Prime is a cost-effective solution for small openings up to 12.25 m² and normal use. Ideal for openings used by pedestrians and materials handling equipment. This door is suitable for a wide range of applications, due in part to its very competitive price.

Specific features:

- robust steel guide side columns fitted with brush seals guide the door curtain
- aluminium bottom beam with a rubber floor profile
- steel U-shaped side guide with brush seals
- light curtain as standard

Options

- available with a FlexEdge bottom beam
- all construction parts in stainless steel
- cover over roller in steel, stainless steel or plastic
- door curtain featuring a print of your choice



Available control units:

T100R

T100R FU

Completely new developed top hood (optional)



FlexEdge bottom beam

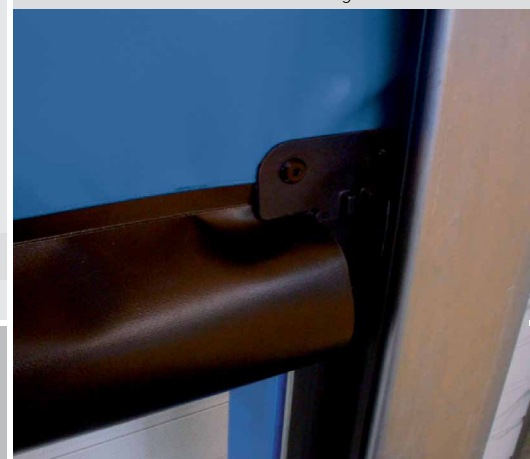

SpeedRoller STRONG

NEW!



The SpeedRoller **Strong** is the innovative standard rapid roll door for intensively used openings. Proven technology guarantees many years of trouble-free operation. Designed for use in general industry and commercial buildings.

Specifications

SpeedRoller	Strong
max. surface area (W x H)	25 m ²
max. width (W)	5,000 mm
max. height (H)	5,000 mm
opening speed	1 m/s
opening speed with frequency control	1.5 m/s
closing speed	1 m/s
closing speed with frequency control	0.5 m/s
door curtain weight	680 gr/m ²
door curtain thickness	0.7 mm

Product Benefits

- Class 0 windresistance or at least 5 Beaufort
- light curtain in the door opening
- suitable for smaller interior openings and normal wind load
- supplied in the following colours as standard:

5005 9004 9003 7038 7024 3020 2009 1003

The most reliable basis for intensive use

Best basis for intensive use

The SpeedRoller Strong is the basic high speed roller door model for intensive use. The door curtain is made of horizontal sections of extremely durable polyester-reinforced PVC. All aspects of the door are robustly designed and well-engineered for every day energy saving, draught exclusion and climate control.

Specific features:

- robust steel guide side columns fitted with brush seals guide the door curtain
- the sections are connected to each other by aluminium stiffener/hinge profiles
- standard vision section
- aluminium bottom beam with rubber floor seal
- light curtain as standard

Options

- available with a FlexEdge bottom beam
- all construction parts in stainless steel
- cover over roller in steel, stainless steel or plastic
- plastic cover over drive



Available control units:

T100R

T100R FU

T100R FU 3 kW

Reinforcement brackets for higher windresistance

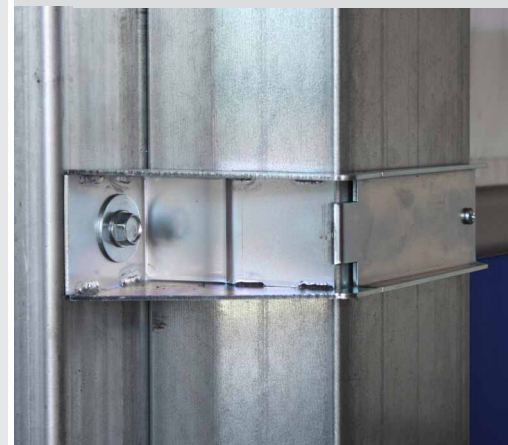

Integrated curtain stiffener/hinge profiles



See the Technical Data on page 28 for more information, or download the Product Data Sheet from www.novoferm.com

NovoSpeed HEAVY | Indoor



The **Heavy Indoor** is a high-speed, electrically operated rapid roll door, specifically designed for interior openings in industrial and commercial buildings.

Specifications

NovoSpeed	Heavy Indoor
max. surface area (W x H)	36 m ²
max. width (W)	6,000 mm
max. height (H)	6,000 mm
opening speed	1 m/s
opening speed with frequency control	1,5 m/s
closing speed	1 m/s
closing speed with frequency control	0,5 m/s
door curtain weight	1,400 gr/m ²
door curtain thickness	1.2 / 3 mm

Product Benefits

- Class 0 windresistance
- safety photocell in the door opening
- completely transparent 'Full Vision' door curtain optional
- supplied in the following colours as standard:

5005

9004

9003

7038

3020

2009

1023

trans-
parent

A tower of strength

Workhorse for large openings

The NovoSpeed Heavy Indoor has been specially developed for large interior openings up to 36 m². All structural components and the curtain are robustly designed and engineered. Overpressure and underpressure can exert considerable forces on the door curtain. With its 1.2 mm thick door curtain and strong aluminium stiffener/hinge profiles, the Heavy Outdoor is capable of withstanding wind loads of up to 5 Beaufort (28 - 38 km/h). Specific features:

- extra strong, fabricated steel side columns with brushes to seal and guide the door curtain
- a bottom beam with a self-testing bottom safety edge and cast aluminium end pieces of as standard
- the aluminium lower beam is available with a 'BreakAway' crash-protection system, which prevents damage in a collision and allows the door curtain to be repositioned in the guides without having to use special tools
- safety light curtains in the guide



T100R



T100R FU

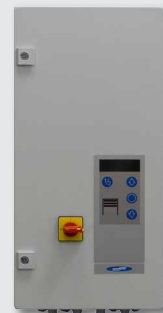

T100R FU 3 kW

Available control units:



NovoSpeed HEAVY



An exterior door should be left open for the shortest possible period of time. A traditional exterior door opens and closes relatively slowly, leading to considerable energy loss. However, energy loss can be minimised by combining a 'slow' exterior door with a rapid roll door.

Specifications

NovoSpeed	Heavy
max. surface area (W x H)	36 m ²
max. width (W)	6,000 mm
max. height (H)	6,000 mm
opening speed	1 m/s
opening speed with frequency control	1.5 m/s
closing speed	1 m/s
closing speed with frequency control	0.5 m/s
door curtain weight	3,000 gr/m ²
door curtain thickness	3 mm

Product Benefits

- Class 0 windresistance
- heavy duty product for high wind loads
- supplied in the following colours as standard:

5010

7023

2002

1021

Robust and energy-efficient

Proven reliability

Wide side columns in combination with a sophisticated tensioning system make a major contribution to the excellent stability offered by the NovoSpeed Heavy. The robust aluminium bottom beam, heavy-duty aluminium stiffener/hinge profiles and 3 mm thick door curtain complete this door's impressive specifications.



Available control units:

T100R

T100R FU

T100R FU 3 kW



See the Technical Data on page 28 for more information, or download the Product Data Sheet from www.novoferm.com

NovoSpeed POLARA

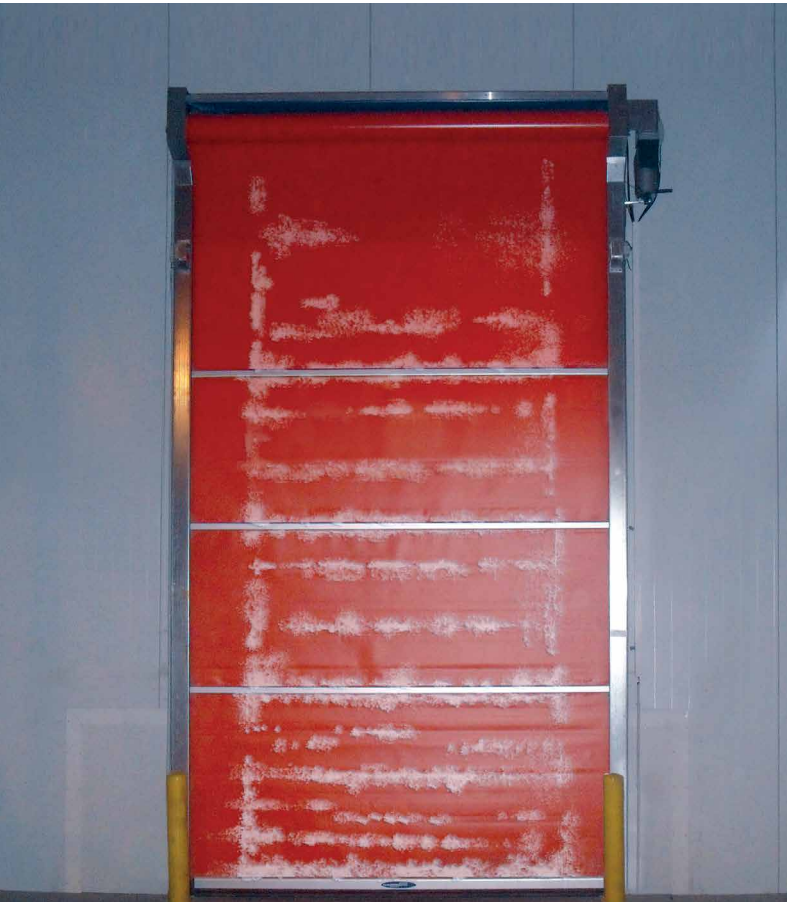

The **Polara** door provides an effective seal in freezer cell openings. All components are heated. The door opens automatically every 15 minutes to prevent icing.

Specifications

NovoSpeed	Polara
max. surface area (W x H)	17.5 m ²
max. width (W)	3,500 mm
max. height (H)	5,000 mm
opening speed	1 m/s
closing speed	1 m/s
door curtain weight	680 gr/m ²
door curtain thickness	0.7 mm

Product Benefits

- Class 0 windresistance
- safety photocell in the door opening
- operates down to -30 ° C
- dual radar for detecting ice
- bottom beam with multilene end pieces
- supplied in the following colours as standard:

5005 9004 9003 7038 7024 3020 2009 1003

Resistant to extreme cold

When hygiene is vital at low temperatures

The Polara is suitable for use in the food industry where stringent hygiene and safety requirements apply when producing and processing fresh foods. Specific features:

- heated side guides
- heated control unit
- heated photocells
- rubber seals instead of brush seals
- IP65 drive and control unit



Standard control unit:

heated control unit



Additional applications

Swing doors

Old-fashioned reliability

A swing door is a manually operated interior door for industrial use. This door system is available in a range of sizes up to 9 m². It owes its continuing popularity today to the following features:

- flexible door curtain in black, grey, transparent or combinations thereof
- simple construction, tried-and-tested design
- mechanical, spring-operated closing mechanism
- no drive unit or controls required
- always opens, also in emergency situations
- easy to maintain and simple to clean
- fast and simple assembly



Easy to fit and inexpensive



EasyClip

Are you looking for an easy-to-install draught-exclusion system for an infrequently used opening? A strip curtain may be the perfect solution.

The ideal strip width and degree of overlap can be selected based on the size of the opening and the type of materials handling equipment. Even though this type of draught exclusion system has been used for decades, its unique benefits still make it a popular choice today:

- flexible strips with good transparency
- effective noise reduction to 30 dB
- simple strip hanging system
- fast and simple assembly
- strips are easy to replace
- orange end strips (option)
- also available for freezer cell applications down to -30°C (optional)

Minimise unnecessary energy loss



An exterior door should be left open for the shortest possible period of time. A traditional exterior door opens and closes relatively slowly, leading to considerable energy loss. However, energy loss can be minimised by combining a 'slow' exterior door with a rapid roll door.

The traditional sectional door is opened in the morning and closed at night. The rapid roll door seals the opening during the working day. The high speeds at which it opens and closes minimise the air flows that cause energy loss. The NovoSpeed range of exterior doors has obviously been designed to withstand the extreme conditions in which these doors operate.

An investment that pays for itself!

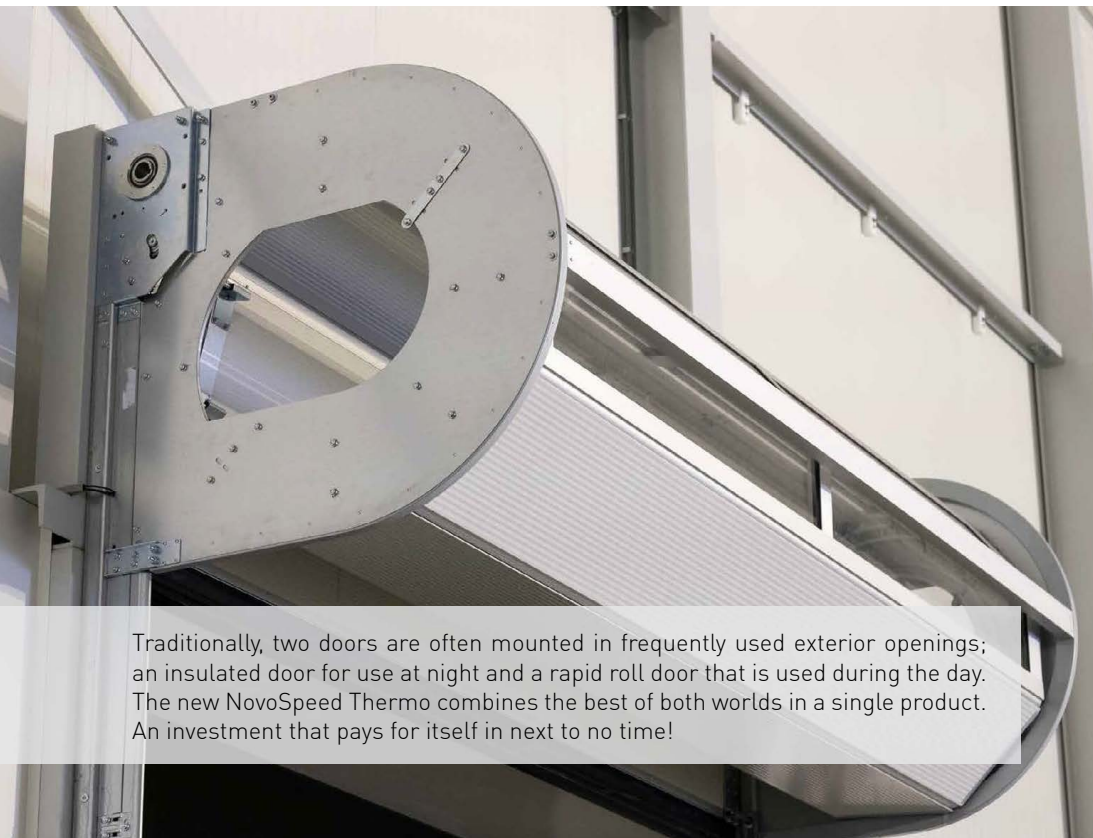

Traditionally, two doors are often mounted in frequently used exterior openings; an insulated door for use at night and a rapid roll door that is used during the day. The new NovoSpeed Thermo combines the best of both worlds in a single product. An investment that pays for itself in next to no time!

NovoSpeed THERMO



Novoferm sets itself ambitious targets in the areas of insulation, noise and pricing. Our research & development department has succeeded in developing a very fast sectional door that also offers excellent insulation performance: The NovoSpeed **Thermo**. Specially designed rollers keep noise to a minimum. This patented system also contributes to the sleek design of the NovoSpeed Thermo. The Directly driven ALU torsion tube and guidance based on a continuous chain/belt system is virtually maintenance free.

Specifications

NovoSpeed	Thermo
max. surface area (W x H)	25 m ²
max. width (W)	5,000 mm
max. height (H)	5,000 mm
opening speed	1,1 m/s
closing speed	0,5 m/s
panel thickness	40 mm
finish	galvanized steel

Product Benefits

- Class 3 / 4 windresistance
- high insulation value $U = 1,77 \text{ W} / \text{m}^2\text{K}$ when the door is fully closed (up to 5 x 5 m)
- high opening speed
- low noise due to vibration-free operation

The fast, space-saving spiral door

Fast all-in-one exterior door

The NovoSpeed Thermo is a contemporary innovation that hardly takes up any space thanks to the innovative spiral wind-up system. The door is not folded but rolled up as it were, in a way that prevents the laths from making contact with each other. This prevents door wear. A NovoSpeed Thermo is an ideal solution in areas where the structural ceiling arrangement does not offer enough space for a sectional overhead door. Also available as S600 version, with horizontal rails instead of a spiral.

Energy-conscious

You can easily reduce energy costs by opening and closing exterior doors at high speed. The NovoSpeed Thermo opens at a speed between 1.1 m/s.

Panel surface finishes and colours

Available in a micro line profiled finish. The door is offered in RAL 9002 as standard, but can optionally be painted in any (approximation of a) RAL colour.



Standard control unit:

TS 971



New development by Novoferm!



Spiral wind-up system

Compact hinge design

NovoSpeed ALU R



The NovoSpeed **Alu R** is a high-speed exterior door that offers good insulation.

Specifications

NovoSpeed	Alu R
max. surface area (W x H)	25 m ²
max. width (W)	5,000 mm
max. height (H)	5,000 mm
opening speed	1 m/s
closing speed	0.5 m/s
slat height (visible)	80 mm
slat thickness	20 mm
slat wall thickness	0.66 mm
slat material	anodised aluminium E6/EV1

Product Benefits

- Class 2 wind resistance (EN 12424) up to a door size of 5 x 5 m
- frequency control included as standard
- compact size for easy installation
- U-shaped side guides
- supplied in the following colours as standard:

7016

9007

9006

9002

9010

Cost-effective aluminium roller shutter

Universal roller shutter door

When speed is not a decisive factor, the NovoSpeed Alu R is an ideal solution.

Besides offering an attractive appearance, this door's opening speed of 1 m/s makes it suitable for universal use in interior and exterior openings. As door panel balancing is not required, the NovoSpeed Alu R is compactly dimensioned with smaller side guides and a less powerful drive. This simplified design approach significantly reduces the cost of the door without affecting reliability. Specific features:

- opening speed of 1 metre per second
- one or multiple viewing slats are optionally available

Colours

The door is offered in a standard range of RAL colours and can optionally be painted in any (approximation) RAL colour.

Standard control unit:



TS 971



NovoSpeed HEAVY | Outdoor



The NovoSpeed **Heavy Outdoor** is a rapid rolling door with electric drive. Applications are in industry and public utilities with exterior openings.

Specifications

NovoSpeed	Heavy Outdoor
max. surface area (W x H)	36 m ²
max. width (W)	6,000 mm
max. height (H)	6,000 mm
opening speed	1 m/s
opening speed with frequency control	1.5 m/s
closing speed with frequency control	0.5 m/s
closing speed	1 m/s
door curtain weight	3,000 gr/m ²
door curtain thickness	3 mm

Product Benefits

- Class 2 windresistance
- aluminium reinforcing profile with guide wheels at the ends
- heavy duty product for outdoor use and high wind loads
- supplied in the following colours as standard:

5010

7023

2002

1021

For large, heavily used corridors

The fast and reliable exterior door

When fitted behind a sectional door or roller shutter, the NovoSpeed Heavy Outdoor creates a more pleasant working environment and saves energy.

The traditional sectional door is opened in the morning and closed at night. The rapid roll door seals the opening during the working day. The high speeds at which it opens and closes minimise the air flows that cause energy loss. The NovoSpeed range of exterior doors has obviously been designed to withstand the extreme conditions in which these doors operate.



Available control units:

T100R

T100R FU 3 kW



Larger wind resistance with guide wheels!

NovoSpeed Control units

Technical Specifications

	items	
controls	push-buttons open-stop-close	
	external push-buttons (open-stop-close or timer)	
	pull switch	
	radar	
	receiver (keeloq) / multibit	
	infrared detector	
	2 channel infrared detector	
	2 channel induction loop detector (separate)	
use	NovoSpeed door control unit for use with:	Prime
		Strong
		Retail
		Heavy
		Heavy Indoor
		Heavy Outdoor
		Flex
connection for pulse generator	DES	
	NES	
optional extras	paired door interlock with control transfer function	
	flashing light	
	traffic light red/green (A800 option)	
	door position detection	
	acoustic signal when closing (option)	
options	3 voltage-free relays	
	receiver (keeloq) / multibit (built in)	
	infrared detector for zone safety monitoring in front of the door opening	
	light screen for safety monitoring in the door area	
wiring	400 VAC ± 10%, Connection for 5-pin CEE plug	
	230 VAC ± 10%, Connection for 3-pin CEE plug	
serial	two additional voltage-free contacts	
	socket for induction loop detector (pre-wired)	
	2 x mounting profile 70 mm	
housing and power supply	steel housing with membrane push-buttons (open-stop-close)	
	plastic housing with membrane push-buttons (open-stop-close)	
	power supply 1x230VAC, slow-blow fuse 10A, 1m CEE-plug, 16A	
	power supply 3x400VAC, slow-blow fuse 10A, 1m CEE-plug, 16A	
	IP65 housing	

Accessories



Push-button
mushroom head
(face-fit)



Safety photocell
with Housing
with reflector

Ixio S
infrared for interior use to H = 3,5 m



Push-button set
up-stop-down
(face-fit)



Pull switch

Ixio D
infrared and movement sensor for
interior use to H = 3,5 m



Push-button set
up-stop-down
key-operated switch
(face-fit)



Key-operated
switch



Radar detector
movement sensor for
interior and exterior
use to H = 6 m



Hand transmitter
2-channel or
4-channel



Adjustable
photocell bracket
galvanized steel



Condor
infrared and
movement sensor
for interior and
exterior use to
H = 6 m



ClearWave
switches without
touching



Support bracket
for radar or traffic
lights



Induction loop
detector
in separate housing



Light curtain
presence detection
in the door opening to
a maximum
height of 2,500 mm



Console
protects the guides
in the event of a
collision



Traffic light
red



Receiver
for remote control
(also available in
housing)



Protective Bollards
galvanized or powder-
coated, bolted or cast
in concrete



Traffic light
red/green

Additional Controls

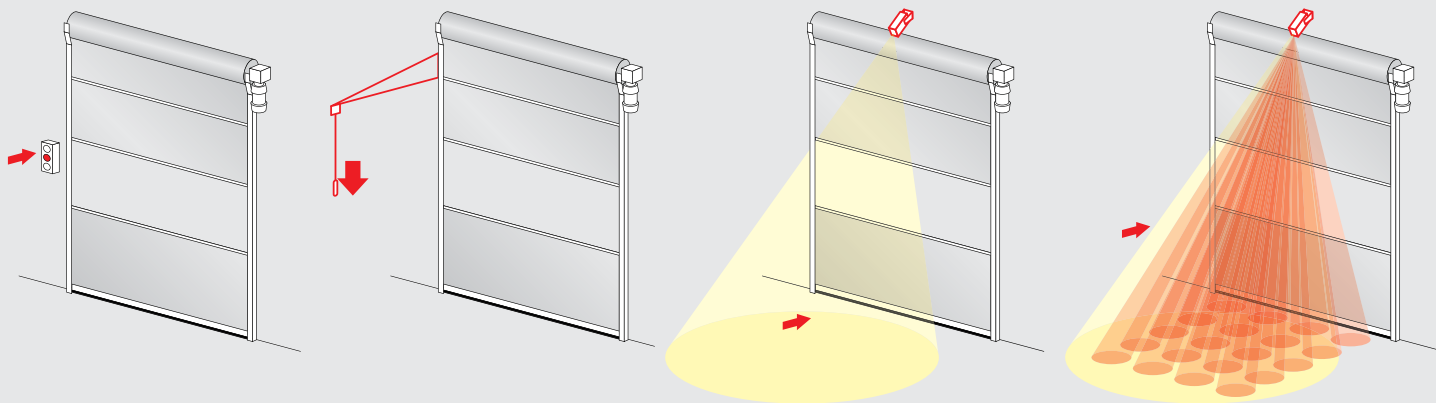

Push-button

Push-buttons are used predominantly for pedestrian traffic. In situations where the hands are not always free, mushroomhead push-buttons offer a solution.

Pull switch

The pull switch is used mainly for forklift truck traffic so the driver can operate the door without getting out of the vehicle.

Radar detector

Radar devices only detect moving objects. The radar detector has a conical detection area and is direction-sensitive. The size, direction and sensitivity of the radar detection field are adjustable.

Condor

The Condor combines two functions in one appliance. Radar for the detection of moving objects (door command) and active infrared for the detection of stationary objects (safety).

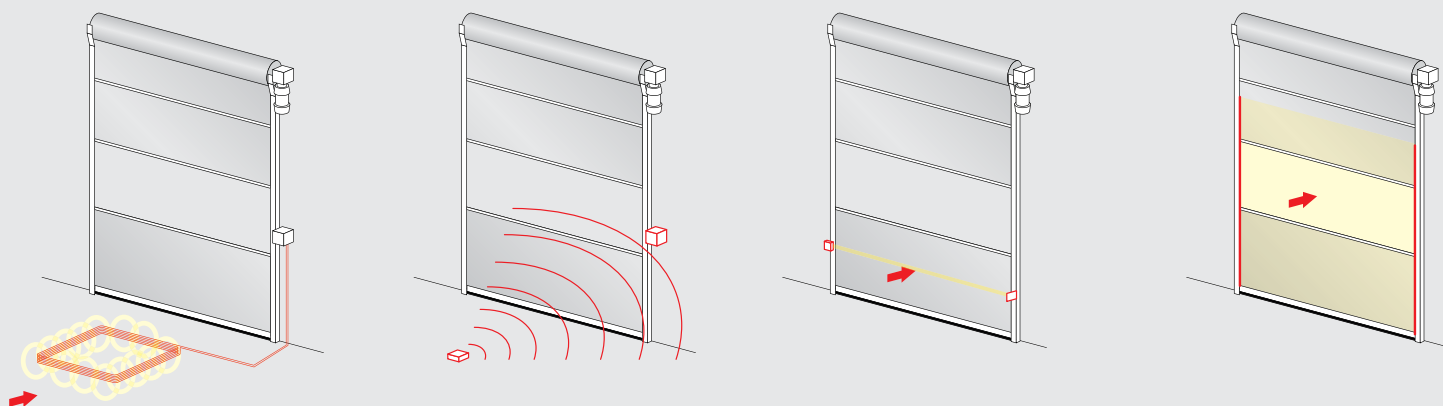

Induction loop

An induction loop creates a magnetic field. When metal objects enter the field, they are detected. Consequently, the induction loop detector is suitable for forklift truck traffic as a door control or extra safety device to prevent the door from closing.

Remote control

Radio remote control operation (transmitter and receiver) allows selective operation. Only vehicles or personnel with a transmitter can open or shut the door. The transmitters may have one or more channels.

Photocell

Photocells are mainly used to monitor the door opening. The door will not close when the photocell beam is interrupted. Designs with a reflector and with a transmitter and receiver are available.

Light curtain

Because a light curtain has a larger detection range, it offers greater safety than a photocell. This form of detection is highly suited to a large variety of vehicle and load sizes.







Technical data

Rapid roll doors with a flexible door curtain

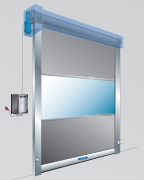

	items	units	Retail	
application	interior door		★	
	exterior door			
speed	T100R Control unit	opens in m/sec (approx.)		
		closes in m/sec (approx.)		
	T100R FU mit Frequenzregelung	opens in m/sec (approx.)	2	
		closes in m/sec (approx.)	0.5	
safety equipment	EN 13241		★	
wind-resistance	Beaufort		3 (12 - 19 km/h)	
windload class	EN 12424		Class 1	
wind protection system	blocks / stiffener - hinge profile		★ / -	
door sizes	width	maximum in mm	2,250	
	height	maximum in mm	2,600	
	maximum surface area	maximum m ²	5.85	
overall size	drive side	clear width + mm	55 / 335	
	bearing side	clear width + mm	55 / 150	
	height	clear height + mm	400	
	width with protective cover	clear width + mm	140 / 235	
	height with protective cover	clear height + mm	440	
	depth	from the wall = mm		
	depth with protective cover	from the wall = mm	420	
	T100R control unit, plastic housing [IP65]	w x h x d = 219 x 256 x 117 mm		
	T100R large control unit with add-on [IP65]	w x h x d = 219 x 550 x 117 mm		
	T100R FU 1,5 kW [IP65]	w x h x d = 219 x 550 x 117 mm	★	
T100R FU 3 kW	w x h x d = 300 x 600 x 160 mm			
'break-away'-system	manual re-feed			
'anti-crash'-system	auto 're-feed' (self-repairing)		★ (1 side)	
door construction	self-supporting		★	
door curtain	transparent vision/window section thickness	0.8 / 3 mm	0.8 mm	
	coloured Synthetic thickness	0.7 / 1.2 / 3 mm	0.7 mm	
curtain	tensioning system			
guide material / surface finish	galvanised steel		★	
	stainless steel V2A, smoothed (304)		○	
	aluminium			
	painted in a choice of RAL colours		○	
drive and control	mechanical cam-type limit switch			
	electronic limit switch DES		★	
	mains supply		1 x 230V, N, PE	
	fuse		16A slow	
	supply voltage (single phase) 230V		★	
	supply voltage (three-phase) 400V			
	main switch		★	
	emergency stop		★	
	presence detection in the door opening	photocell + safety edge		
		light screen		★
		radar detector		○
	safety edge device	wireless signal transfer		
		coil cable		
emergency opening	crank			
	emergency hand chain			
	counterweight / spring		○	
	B-Brake		○	
	mechanical emergency release		○	
voltage-free contacts	UPS with frequency control, 230V	with frequency control only	○	
			2	

★ = Standard
○ = Optional

							
Flex Hard Edge	Flex Flex Edge	Prime	Strong	Polara	Heavy Indoor	Heavy	Heavy Outdoor
★	★	★	★	★	★	★	★
		1	1	1	1	1	
		1	1	1	1	1	
2	2	1,5	1,5		1,5	1,5	1,5
0.5	0.5	0.5	0.5		0.5	0.5	0.5
★	★	★	★	★	★	★	★
5 (29 - 38 km/h)	5 (29 - 38 km/h)	5 (29 - 38 km/h)	5 (29 - 38 km/h)	3 (12 - 19 km/h)	5 (29 - 38 km/h)	8 (62 - 74 km/h)	10 (max. 90 km/h)
Class 0	Class 0	Class 0	Class 0	Class 0	Class 0	Class 0	Class 2
★ / -	★ / -	○ / -	○ / ★	- / ★	- / ★	- / ★	- / ★
4,000	3,500	3,500	5,000	3,500	6,000	6,000	6,000
5,000	5,000	3,500	5,000	5,000	6,000	6,000	6,000
20	17.5	12.25	25	17.5	36	36	36
210	210	300	300	290	470	470	470
210	210	170	170	160	275	275	250
450	450	350	350	850	710	710	660
320	320	410	410		775	775	750
500	450	460	460		750	750	660
		325	325	350	400	400	380
420	420	430	430		400	400	410
		★	★	SMD*	★	★	★
		○	○		○	○	○
★	★	○	○		○		○
			○		○		★
				★	○	○ (≤ 4500 wide)	
★	★						
★	★						
0.8 mm	0.8 mm	0.8 mm	0.8 mm	0.8 mm	0.8 mm	3 mm	3 mm
1.2	1.2	0.7 / 1.2 mm	0.7 / 1.2 mm	1.2 mm	1.2 / 3 mm	3 mm	3 mm
		★	★		★	★	★
		○	○	○		★	★
★	★						
○	○			○	○	○	○
★	★	★	★	★	★	★	★
1 x 230V, N, PE	1 x 230V, N, PE	3 x 400V, N, PE	3 x 400V, N, PE	3 x 400V, N, PE	3 x 400V, N, PE	3 x 400V, N, PE	3 x 400V, N, PE
16A slow	16A slow	16A slow	16A slow	16A slow	16A slow	16A slow	16A slow
★	★	○	○	○	○		
		★	★	★	★	★	★
★	★	○	○	○	○	○	○
○	○	○	○	○	○		
		★	★		★	★	★
★	★	★	★	-	○	○	○
○	○	○	○	○	○	○	○
		★	★		★	★	★
		★	★	★	★	★	★
		○	○		○	○	○
- / ○	- / ○						
○	○						
○	○						
○	○	○	○		○	on request	on request
2	2	2	2	2	2	2	2

* outside of freezer cell

Technical data

Rapid roll doors with rigid door panels



	item	units	Thermo	Alu R	
application	inside door				
	outside door		★	★	
speed	motor contactor control	opens in m/sec. (approx.)			
		closes in m/sec. (approx.)			
	frequency control	opens in m/sec. (approx.)	1.1	1	
		closes in m/sec. (approx.)	0.5	0.7	
safety equipment	DIN EN 13241		★	★	
wind load class	DIN EN 12424		Class 3/4	Class 2	
resistance penetrating water	DIN EN 12425		Class 2	Class 2	
air permeability	DIN EN 12426		Class 2	Class 2	
heat transfer	DIN EN 12428		0	0	
noise-attenuation	DIN EN 52210	dB	20	20	
dimensions	width	maximum in mm	5,000	5,000	
	height	maximum in mm	5,000	5,000	
overall size	drive side	clear width + mm	350	300	
	bearing side	clear width + mm	120	170	
	lintel	clear width + mm	240	450	
	Height	clear height + mm	1100	850	
	drive side with protective cover	clear width + mm		350	
	bearing side with protective cover	clear width + mm		250	
	lintel with protective cover	clear width + mm		600	
	height with protective cover	clear height + mm		730	
	frequency control FUE 1,5 kW	w x h x d = 300 x 350 x 150 mm			
	frequency control FUE3-C 4 kW	w x h x d = 300 x 450 x 150 mm			
	GFA TS971	w x h x d = 155 x 380 x 80 mm	★	★	
	door construction	self-supporting			
	door curtain	profiles, double-walled, thickness in mm		40	20
		thermally insulated profile		★	★
door curtain material	aluminium anodised E6/EV1			★	
	aluminium with RAL powder coating	colour of choice	○	○	
glazing	synthetic windows, double		○	○	
ventilation	ventilation opening				
guide material / surface finish	galvanised steel / aluminum		★ / -	★ / -	
	steel painted in a choice of RAL colours		○	○	
drive and control	frequency control		★	★	
	supply voltage (single phase)			★	
	supply voltage (triple-phase)		★	> 16 m ²	
	membrane push-buttons, Open-Stop-Close		★	★	
	frequency control, main switch, switches off all poles		★	★	
	fuse		16A T	16A T	
	protection class	drive control	IP 65	IP 65	
	emergency stop		○	○	
	presence detection in door opening	photocell		★	
		light screen	★	○	
	safety edge device	with articulated cable carrier			★
		with coil cable			★
		with wireless signal transfer		★	○
	electronic limit switch DES		★	★	
emergency opening	crank		★	★	
	emergency hand chain		○	○	
	counterweight/spring				
	UPS with frequency control, 230V				
voltage-free contacts			2	2	

★ = Standard
○ = Optional

References



Novoferm offers more...

You can download these brochures and more from our site www.novoferm.com

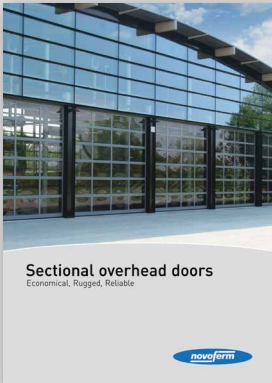

Sectional overhead doors

- insulated panels
- glazed panels
- wide variety in size, speed, insulation and appearance



Rolling shutters in aluminium or steel

- aluminium
- steel



Docking Solutions

- levellers
- shelters
- closing seals
- full loading docks
- air locks

Novoferm. On-site. Direct. Europe-wide.

The Novoferm Group is one of the leading European system suppliers of doors, garage doors, frames and operators. We offer a large range of products and services for private, commercial and industrial applications. All our products are manufactured according to state-of-the-art technology and highest quality standards. We therefore integrate maximum functionality and innovative design. We manufacture our products in various international locations and with our Europe-wide network we are always able to deal with you – wherever you are!

Your Novoferm distributor:



www.novoferm.com

United Kingdom

Novoferm Ltd UK

Phone: +44 (0) 1582 563 777
E-mail: info@novoferm.co.uk
Internet: www.novoferm.co.uk

